

# Archatrak 'Prime' Pedestal

Adjustable height, polypropylene pedestal with concentric screwed columns and self-leveling bi-material head with built in spacer tabs. Just three pedestal models cover the height range from 1 1/8" to 16 1/2", providing greater flexibility and faster installation on site. Prime pedestals are supplied as fully assembled units with base and screwed columns. The self-leveling head with inbuilt spacer tabs and rubber surface is locked in place with a simple twist.

- Only three pedestal models cover the range 1 1/8" to 16 1/2".
- Concentric screwed columns provide continuous height adjustment.
- Safety stop prevents screwing beyond safe limit.
- Self-leveling head enables automatic slope compensation up to 5%.
- Rubber surfaced head with inbuilt spacer tabs offers enhanced slip and shock resistance.
- Wide 4 1/2" diam. body ensures excellent stability at high elevations.
- Large, 46 sq.in. base distributes load and avoids membrane damage.
- Scored base assists in making quick cuts.
- Pre-cut on one side for quick installation at walls.



'PRIME' PEDESTAL

## Specifications & Testing

PROPERTY	DESCRIPTION	SPECIFICATION
Materials	Base and screwed columns Head with inbuilt spacer tabs Spacer tabs (inbuilt)	Polypropylene body Polypropylene with rubber surface 1/2" high x 5/32" thick (std.)
Base	Circular. Scored underneath and cut on one side	8 1/4" dia. 49.6 sq. in.
Central Column	Concentric with hand adjustment rings	4 5/8" to 5 1/4" dia
Head	Self-leveling 5% max. compensation Can be converted to fixed head with optional head lock	5 7/8" diameter
Extension element	Add to PR3	One extension - max height 23" Two extensions - max height 30" Three extensions - max height 37"
Max. Compressive Load		PR 1 - 5058 lb. PR 2 - 5283 lb. PR 3 - 4496 lb. PR 3 + extension - 3034 lb.
Working temp range		-40 °F - 180°F
Ignition temp of plastics	ASTM D1929	Flash Ignition 680°F / Self Ignition 716°F
Rate of burning of plastics	ASTM D635	Pass
Warranty		3 years

## Height Progression



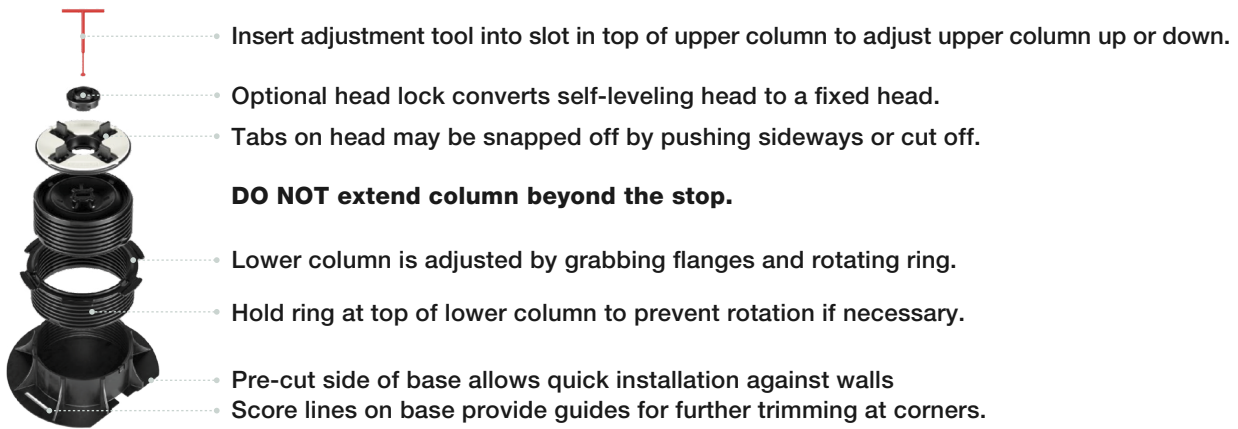

**Pedestal Selection**

Below the lowest height of PR1 pedestal (1 1/4"), use **Archatrak fixed height**, stackable rubber pads PAD 6 (1/4") and PAD 10 (3/8") to build up the height, and LGH2 (1/16") rubber shims for minor height adjustments.

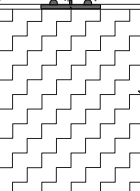
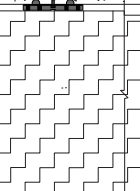
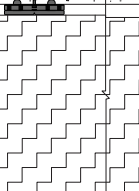
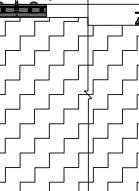
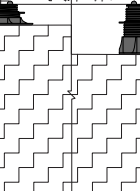
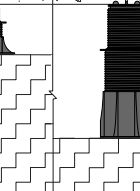
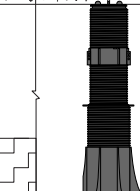
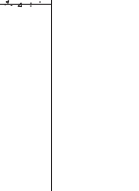
 (Not tabbed) Place on pads for 1/16" height adjustments								
LGH2 shim 1/16"	PAD 6 1/4"	PAD 10 3/8"	PAD 6+PAD 10 5/8"	PAD 6+10+shim 11/16"	PR1 1 1/8" - 2 1/2"	PR2 2 1/2" - 6"	PR3 6" - 16 1/2"	PR3 + Extension(s) 16 1/2" - 37"

For heights over 16 1/2", screw **extension elements** onto PR 3 pedestal between lower and upper columns. Do not exceed heights of 23" with 1 x extension, 30" with 2 x extensions and 37" with 3 x extensions. Guy wires or other approved bracing should be used for pedestal heights above 24". On heights over 16 1/2" consult with our sales team if extra stabilization is needed.

**Layout and Tabs**

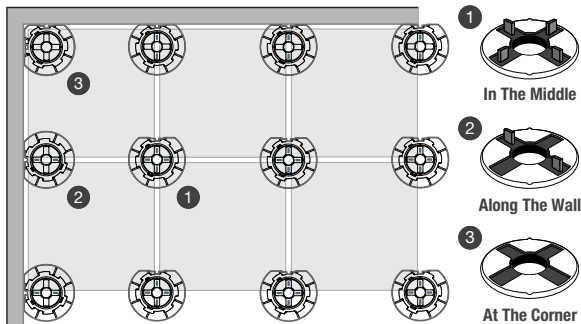

Break off unneeded spacer tabs. At corners of deck area, make an additional cut on base of pedestal at right angles to existing cut.

**Solid Edge Restraint**

Solid edge restraint is required on all sides of the deck. All pavers must be butted as tightly as possible against tabs on pedestal heads. Ensure there is no space exceeding 3/16" between the edge of the pavers and the restraining walls on all sides of the deck. Spring-loaded stainless-steel spacer clips which are installed on the pedestal heads are available from Archatrak to ensure tight containment.

**Break Through Protection**

When laying 2cm porcelain pavers where deck heights exceed 4", appropriate self-adhesive sheets or protection plates should be installed on the underside of the pavers in case of damage due to careless use or accidental impact with heavy tools, heavy or other hard objects. Archatrak 'Spansafe' metal plates, 'Spantrak' FRP grating and 'Shock Contol' 2.0 self-adhesive sheets are available for this purpose.

**Accessories**

