

DETAIL
 NM1: 1" - 1 5/8"

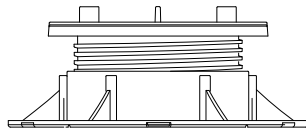

DETAIL
 NM2: 1 5/8" - 2 1/4"

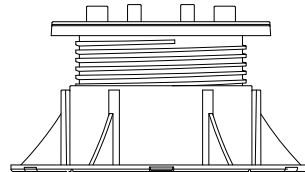

DETAIL
 NM3: 2 1/4" - 3 7/8"

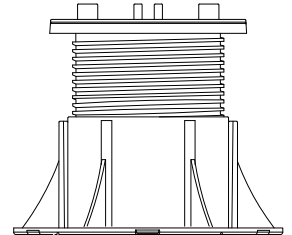

DETAIL
 NM4: 3 1/2" - 6 1/4"

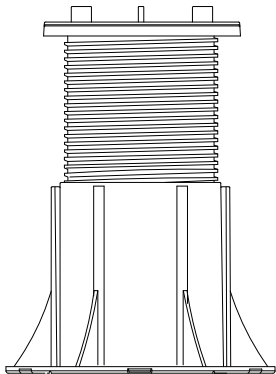

DETAIL
 NM5: 5 7/8" - 10 5/8"

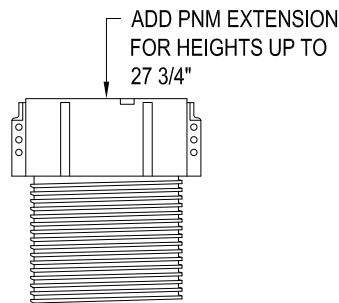

DETAIL
 EXT: 6 1/2"

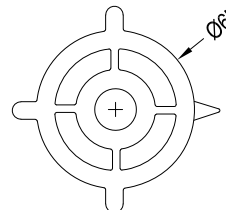

DETAIL
 TW-150: SLOPE
 COMPENSATION RINGS
 1/16" - 1/8"

GENERAL NOTES:

1. INSTALLATION TO BE COMPLETED IN ACCORDANCE WITH ARCHATRAK SPECIFICATIONS.
2. DO NOT SCALE DRAWING.
3. THIS DRAWING IS INTENDED FOR USE BY ARCHITECTS, ENGINEERS, CONTRACTORS, CONSULTANTS AND DESIGN PROFESSIONALS FOR PLANNING PURPOSES ONLY AND SHOULD NOT BE USED FOR CONSTRUCTION.
4. ALL INFORMATION CONTAINED HEREIN WAS CURRENT AT THE TIME OF DEVELOPMENT BUT MUST BE REVIEWED AND APPROVED BY ARCHATRAK TO BE CONSIDERED ACCURATE.

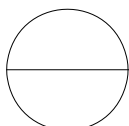

ADJUSTABLE HEIGHT DECK SUPPORTS

NM 'MAXI' SERIES PEDESTALS